

## ELEMENT

char * element_name	boolean accumulate_debit	LIST * subclassification_list
------------------------	-----------------------------	----------------------------------

LIST * account_list
------------------------

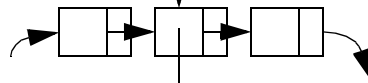

## SUBCLASSIFICATION

char * subclassification_name	LIST * account_list	double subclassification_total
----------------------------------	------------------------	-----------------------------------

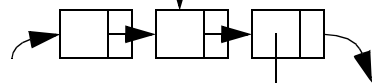
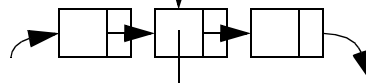

## ACCOUNT

char * account_name	LEDGER * latest_ledger	LIST * journal_ledger_list	char *fund_name char *subclassification_name char *hard_coded_account_key	boolean accumulate_debit double balance double payment_amount
------------------------	---------------------------	-------------------------------	---	---

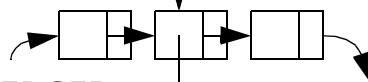

## JOURNAL\_LEDGER

char * full_name	char * street_address	char * transaction_date_time	char * account_name		
double previous_balance	double database_previous_balance	double debit_amount	double credit_amount	double balance	double database_balance

## TRANSACTION

char * full_name	char * street_address	char * transaction_date_time	char * memo
---------------------	--------------------------	---------------------------------	----------------

double transaction_amount	double database_transaction_amount
------------------------------	---------------------------------------

LIST * journal_ledger_list
-------------------------------

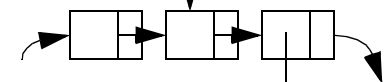

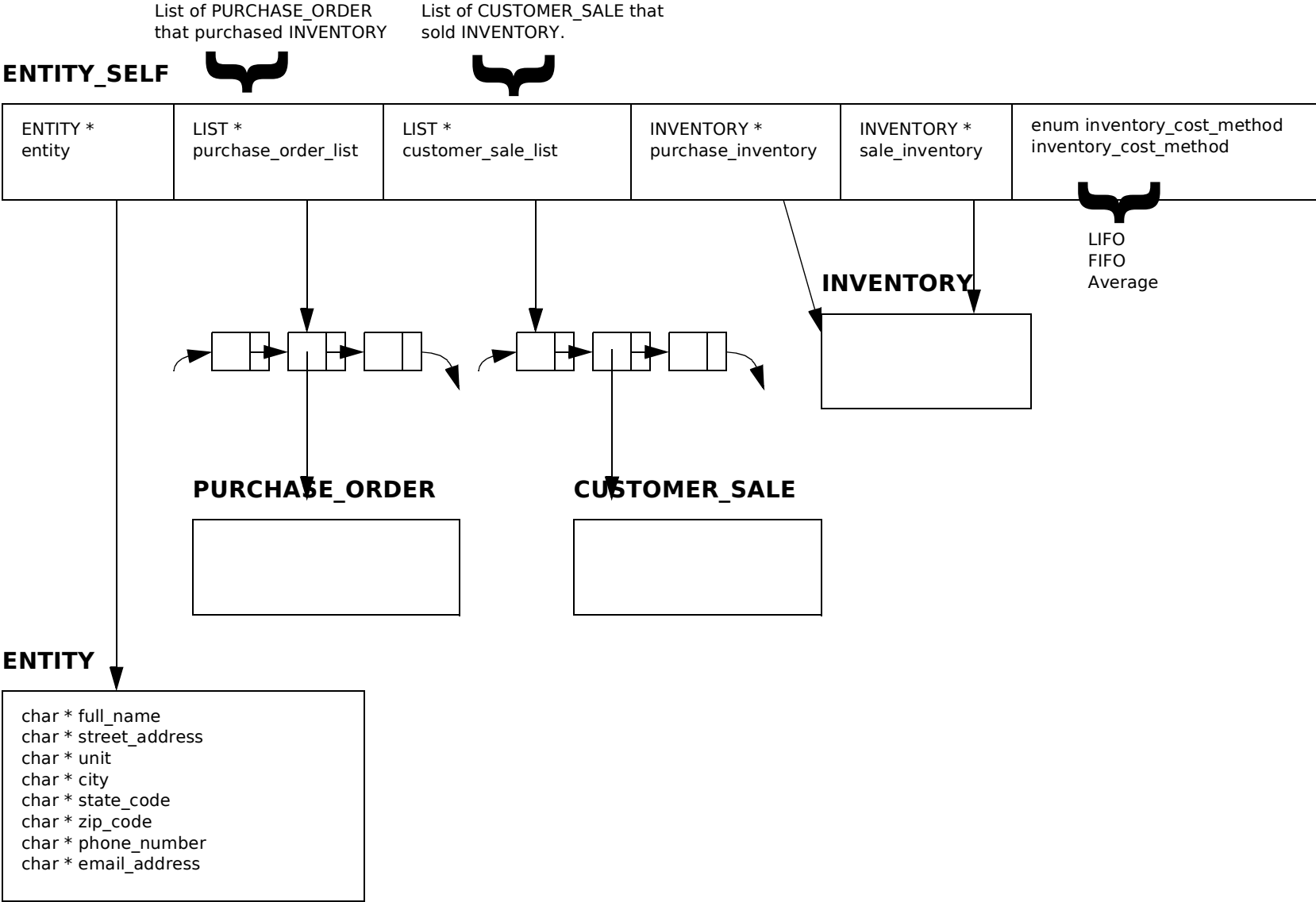

## ENTITY\_SELF (continued)

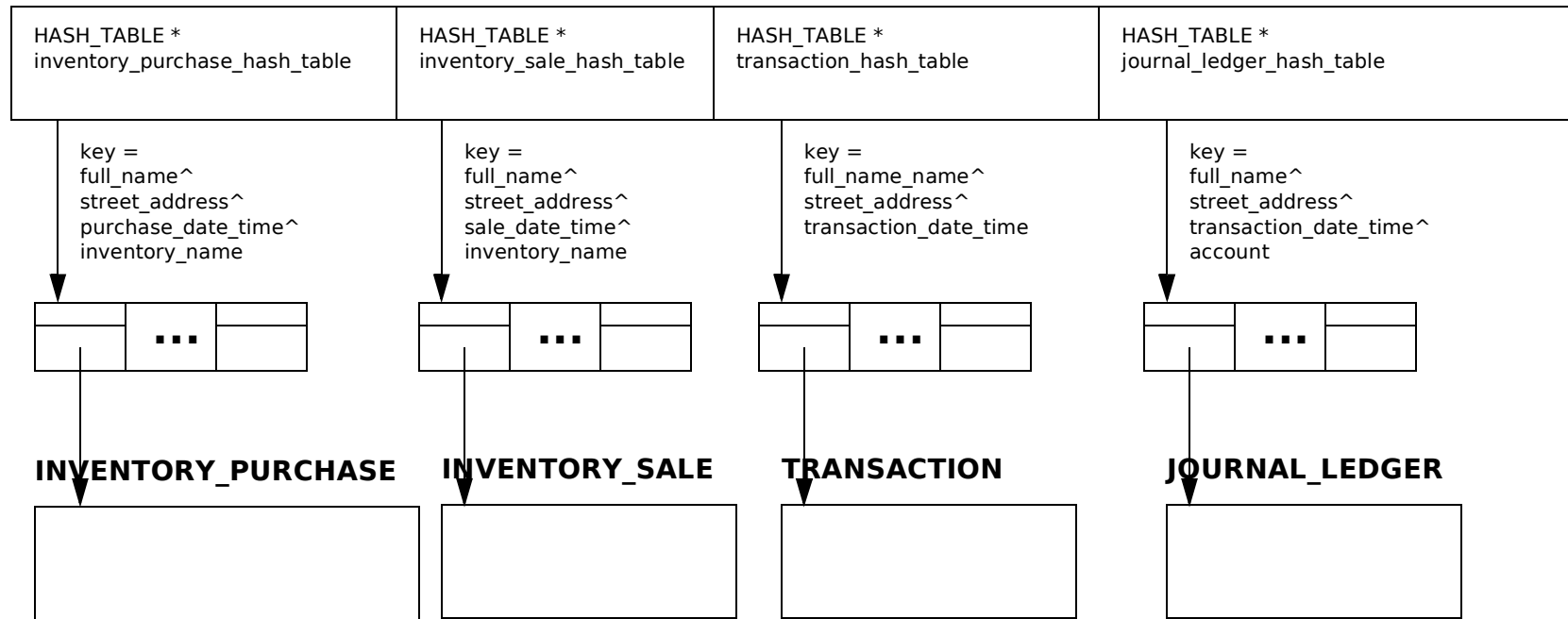

## ENTITY\_SELF (continued)

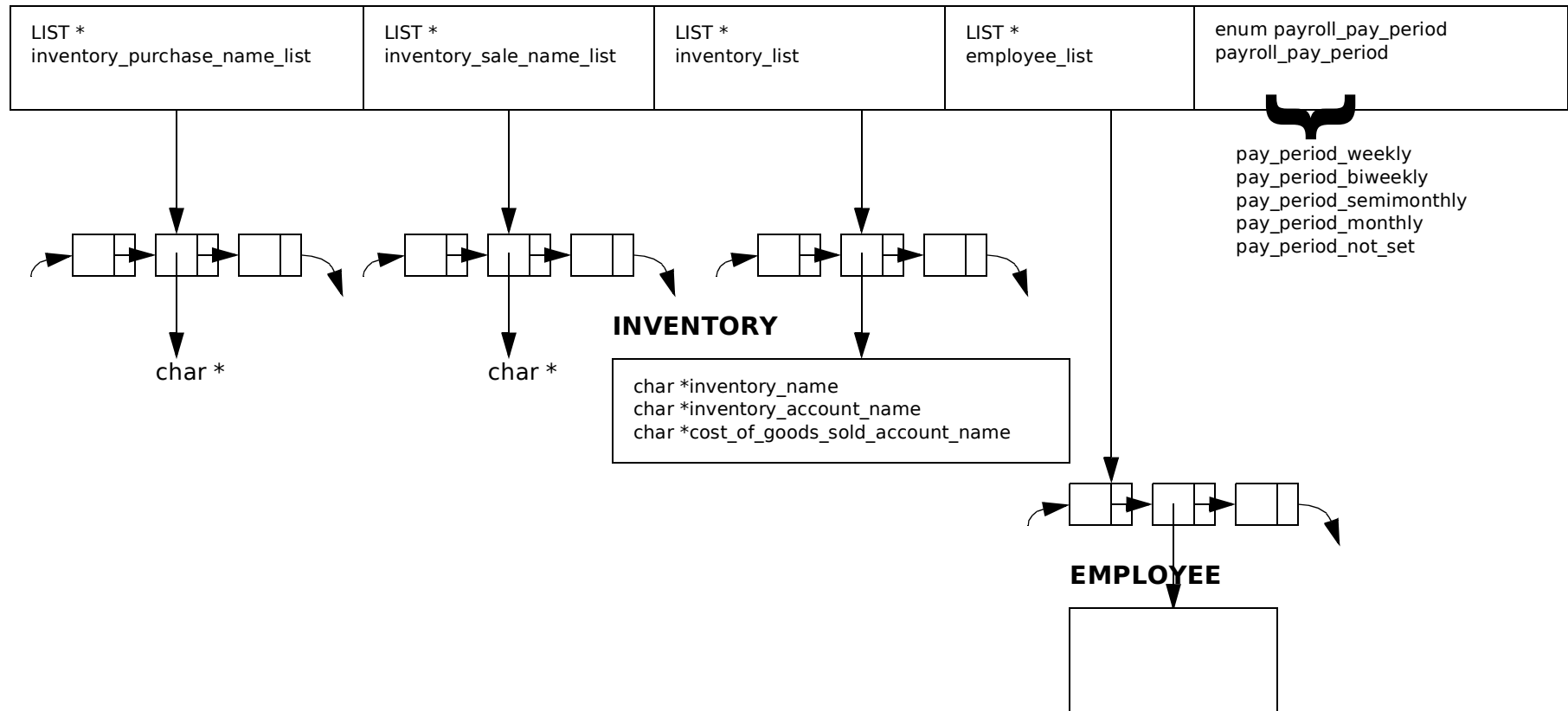

## ENTITY\_SELF (continued)

<pre>char *payroll_beginning_day double social_security_combined_tax_rate int social_security_payroll_ceiling double medicare_combined_tax_rate double medicare_additional_withholding_rate int medicare_additional_gross_pay_floor double federal_withholding_allowance_period_value double federal_nonresident_withholding_income_premium double state_withholding_allowance_period_value double state_itemized_allowance_period_value</pre>	<pre>int federal_unemployment_wage_base double federal_unemployment_tax_standard_rate double federal_unemployment_threshold_rate double federal_unemployment_tax_minimum_rate int state_unemployment_wage_base double state_unemployment_tax_rate double state_sales_tax_rate</pre>
--	---

## CUSTOMER\_SALE (1)

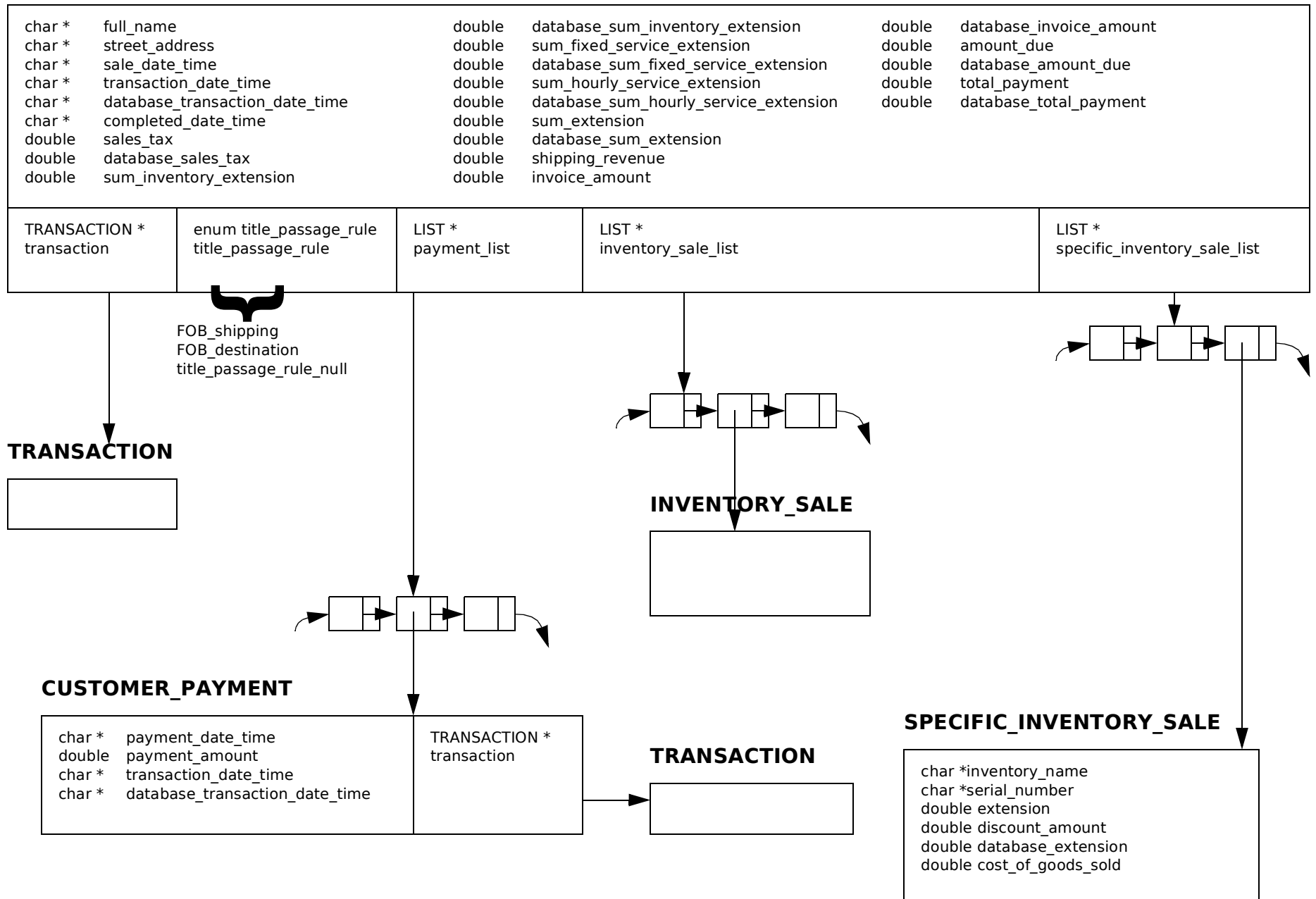

**CUSTOMER\_SALE (2)**

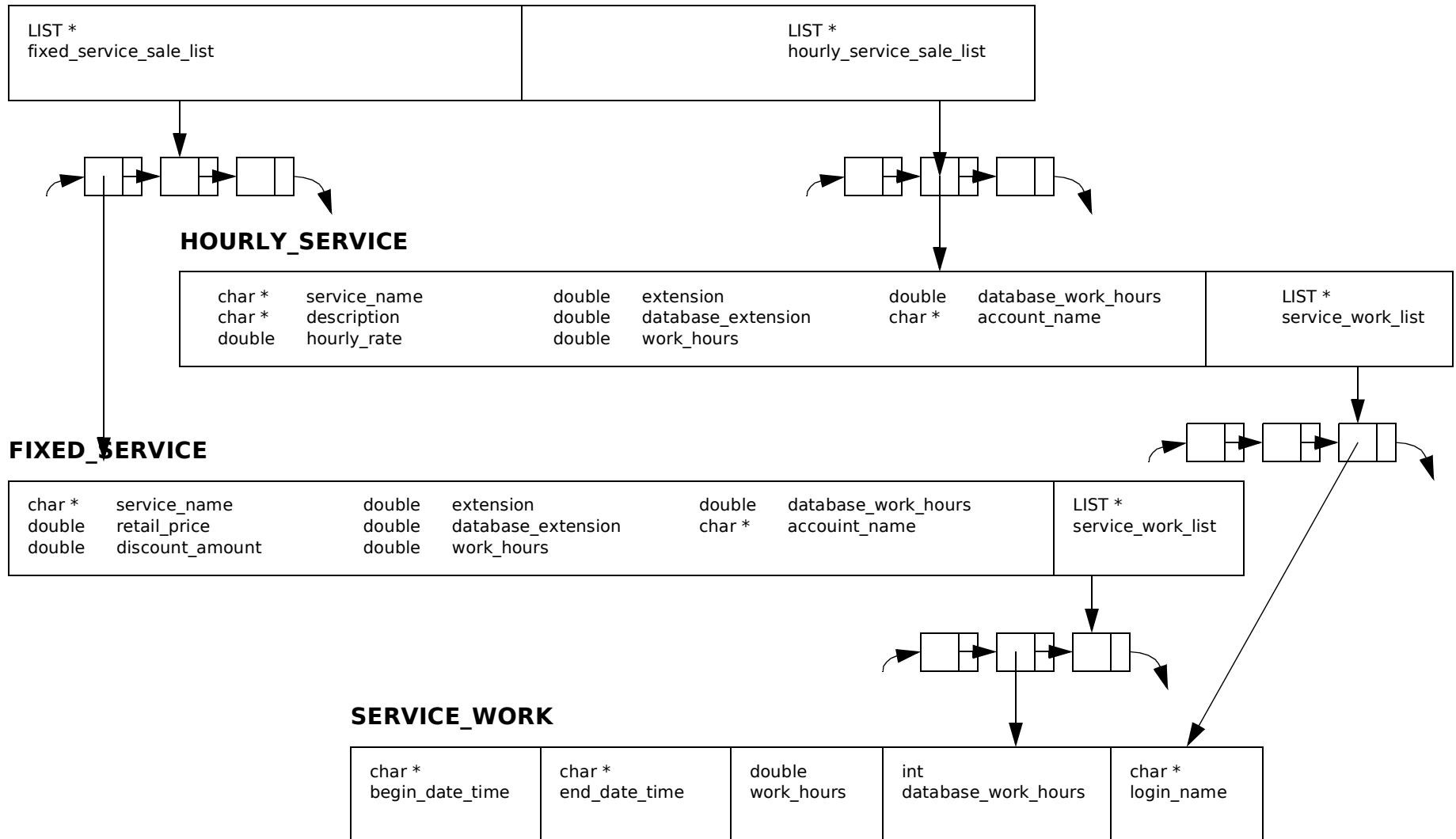

## PURCHASE\_ORDER (1)

char *	full_name	doulbe	sum_extension	double	liability_payment_amount
char *	street_address	double	database_sum_extension	char *	shipped_date
char *	purchase_date_time	double	sales_tax	char *	arrived_date_time
char *	transaction_date_time	double	freight_in	LIST *	service_purchase_list
char *	database_transaction_date_time	double	purchase_amount	TRANSACTION *	transaction
double	sum_inventory_extension	double	database_purchase_amount	char *	property_street_address
double	sum_service_extension	double	sum_payment_amount		
double	sum_fixed_asset_extension	double	amount_due		
double	sum_prepaid_asset_extension	double	database_amount_due		
LIST *	propagate_account_list	enum title_passage_rule	LIST *	LIST *	
	inventory_purchase_list	title_passage_rule	supply_purchase_list	service_purchase_list	

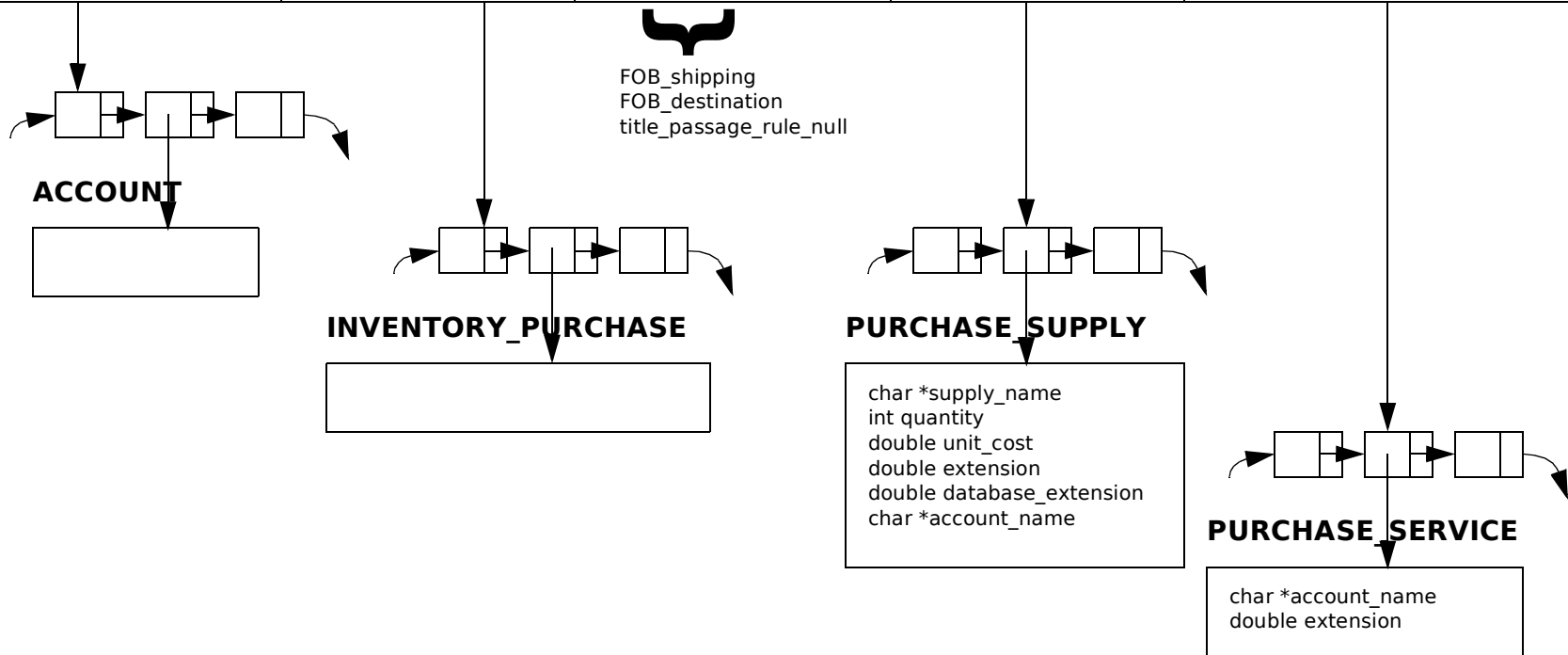

**PURCHASE\_ORDER (2)**

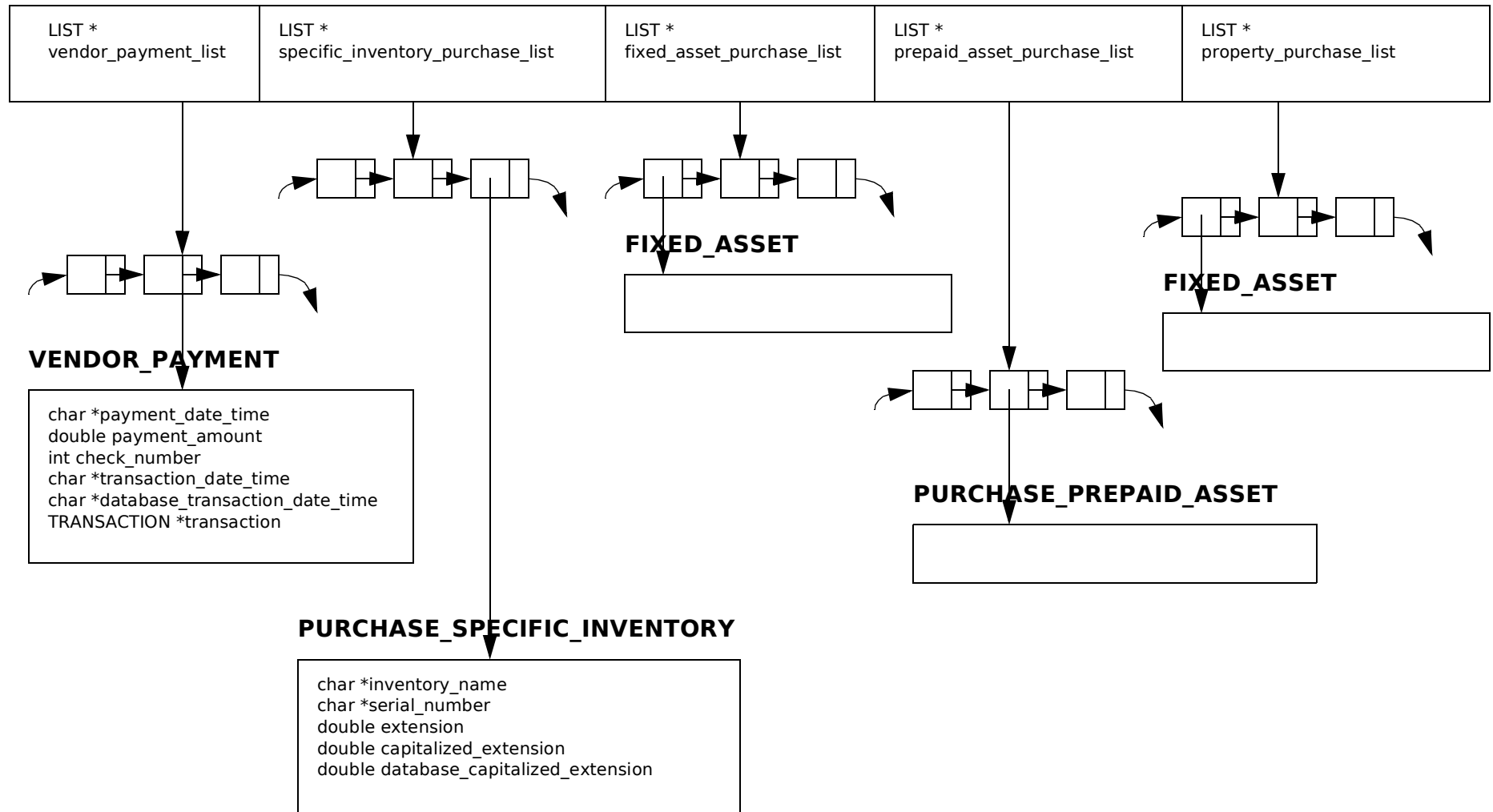



## DEPRECIATION\_STRUCTURE

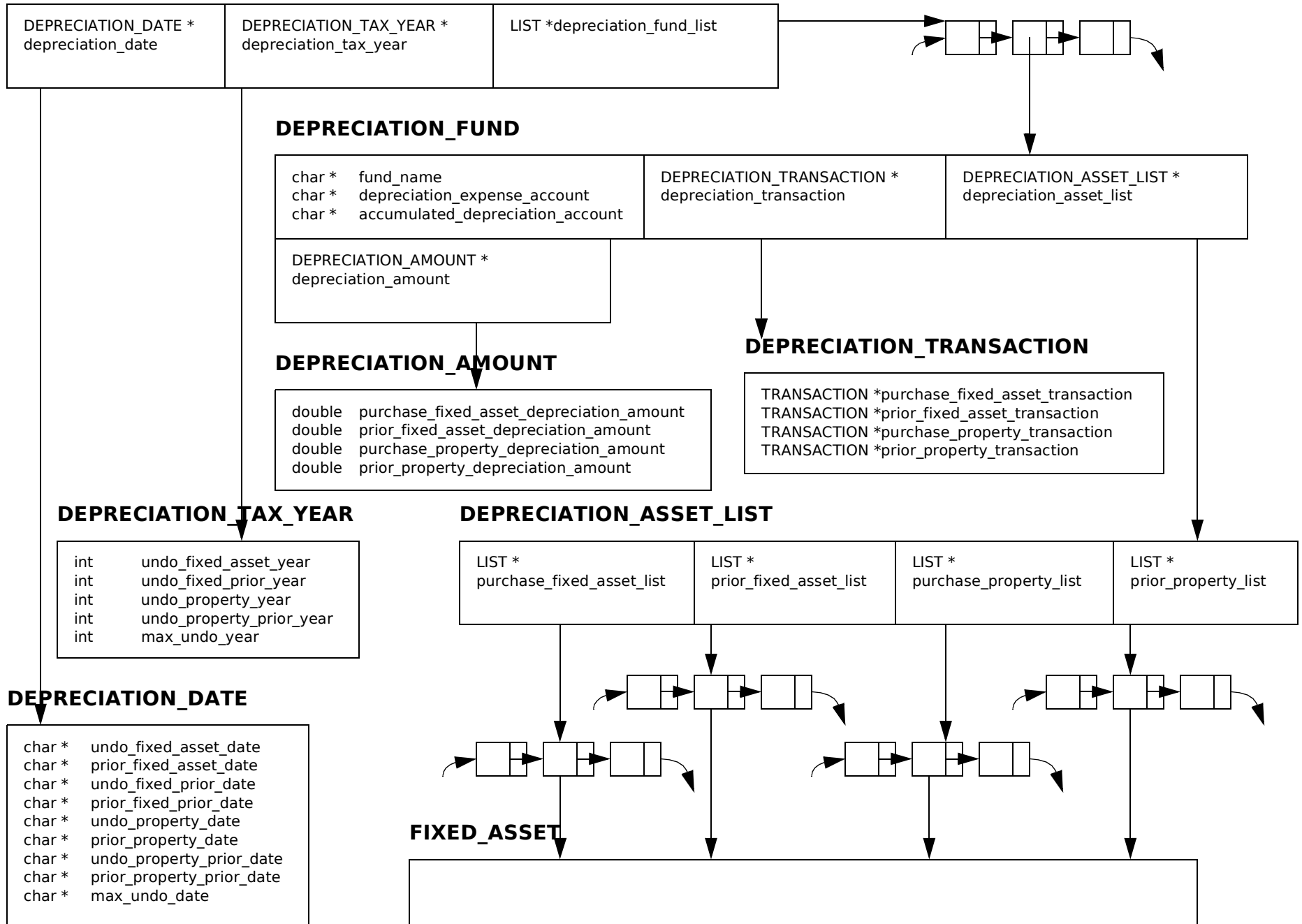

For property, store  
property\_street\_address and  
leave serial\_number null.

## FIXED\_ASSET

char *	asset_name	int	estimated_useful_life_years	double	tax_cost_basis
char *	serial_number	int	estimated_useful_life_units	char *	tax_recovery_period
char *	debit_account_name	int	estimated_residual_value	char *	disposal_date
char *	service_placement_date	int	declining_balance_n	double	finance_accumulated_depreciation
double	extension	char *	depreciation_method	double	tax_accumulated_depreciation

DEPRECIATION \*  
depreciation

TAX\_RECOVERY \*  
tax\_recovery

## DEPRECIATION

char *	depreciation_date
int	units_produced
double	depreciation_amount

## TAX\_RECOVERY

char *	service_placement_date	char *	disposal_date
double	tax_cost_basis	int	tax_year
char *	tax_recovery_period	double	recovery_amount
double	tax_recovery_period_years	double	recovery_percent

**PURCHASE\_PREPAID\_ASSET**

char *	full_name	char *	asset_account_name	double	accumulated_accrual
char *	street_address	char *	expense_account_name	double	database_accumulated_accrual
char *	purchase_date_time	double	extension		
char *	asset_name	double	accrual_period_years		

LIST \*  
accrual\_list

**ACCRUAL**

char *	full_name	double	accrual_amount
char *	street_address	double	database_accrual_amount
char *	purchase_date_time	char *	transaction_date_time
char *	asset_name	char *	database_transaction_date_time
char *	accrual_date	TRANSACTION *	transaction

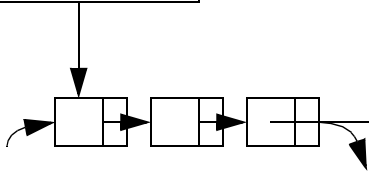

**VENDOR\_PAYMENT**

char *	payment_date_time	double	payment_amount	char *	transaction_date_time	char *	database_transaction_date_time	TRANSACTION *	transaction
--------	-------------------	--------	----------------	--------	-----------------------	--------	--------------------------------	---------------	-------------

**TRANSACTION**

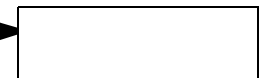

**INVENTORY**

char * inventory_name	double retail_price	int reorder_quantity	char * inventory_account_name	char * cost_of_goods_sold_account_name
LIST * inventory_purchase_list		INVENTORY_BALANCE * last_inventory_balance		LIST * inventory_balance_list
				LIST * inventory_sale_list

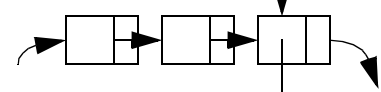
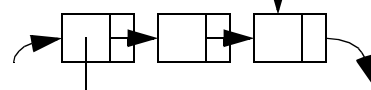
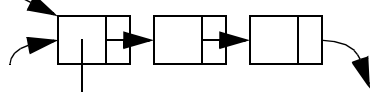

**INVENTORY\_BALANCE**

int quantity_on_hand	double average_unit_cost	double total_cost_balance
INVENTORY_PURCHASE * inventory_purchase		INVENTORY_SALE * inventory_sale

**INVENTORY\_PURCHASE**

char *full_name char *street_address char *purchase_date_time char *inventory_name int ordered_quantity double unit_cost double capitalized_unit_cost double database_capitalized_unit_cost double extension double database_extension int arrived_quantity	int database_arrived_quantity int missing_quantity int quantity_on_hand int database_quantity_on_hand double average_unit_cost double database_average_unit_cost char *arrived_date_time char *inventory_account_name
---	--

**INVENTORY\_SALE**

char *full_name char *street_address char *sale_date_time char *inventory_name int quantity double retail_price double discount_amount double extension double database_extension double cost_of_goods_sold double database_cost_of_goods_sold char *completed_date_time char *inventory_account_name char *cost_of_goods_sold_account_name
--

## PAY\_LIABILITIES

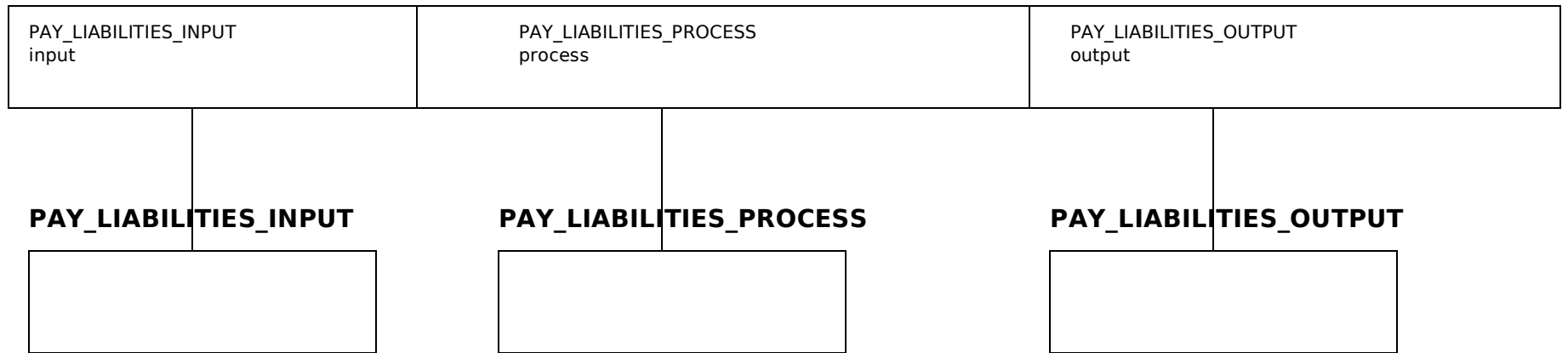

**PAY\_LIABILITIES\_INPUT**

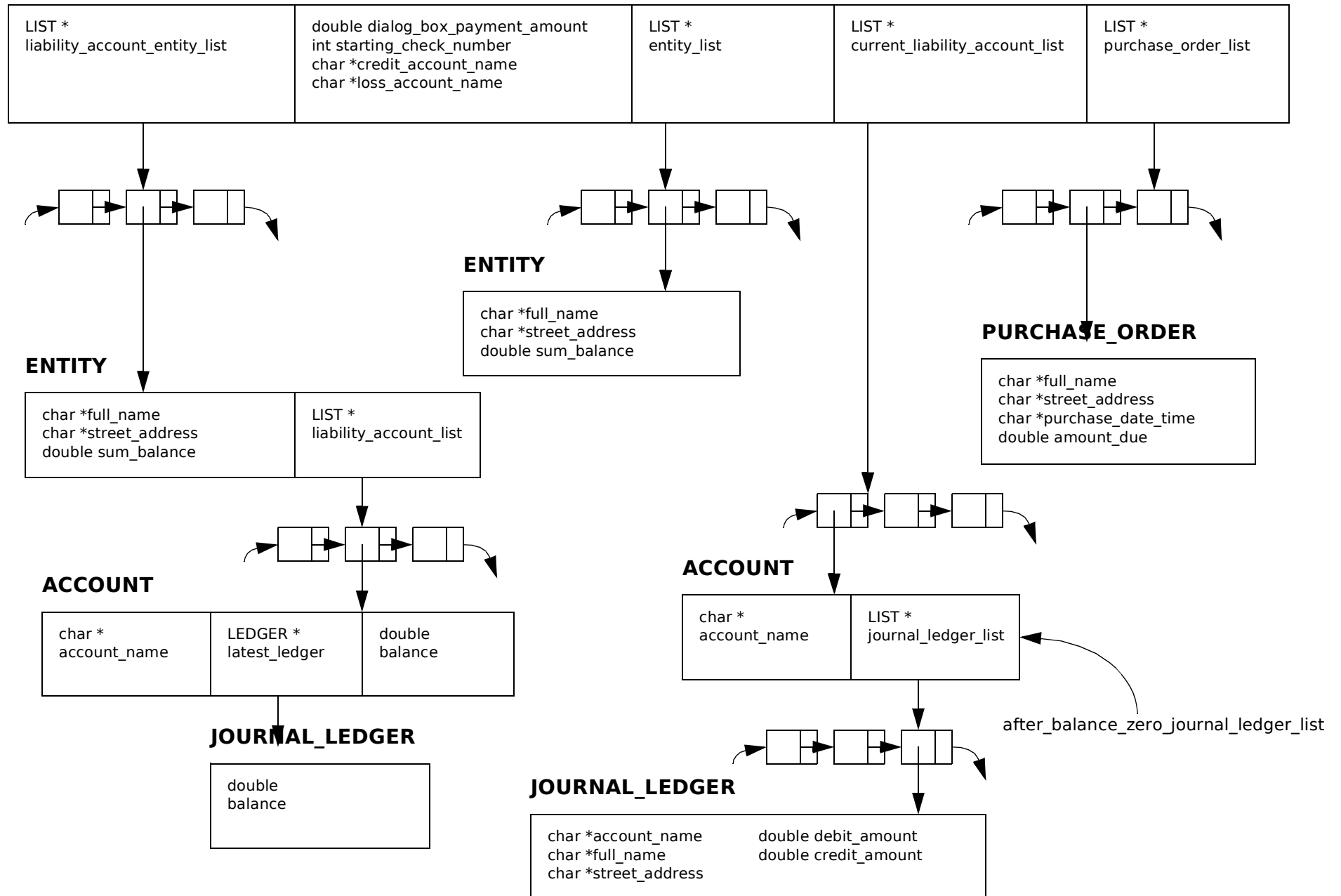

**PAY\_LIABILITIES\_PROCESS (1)**

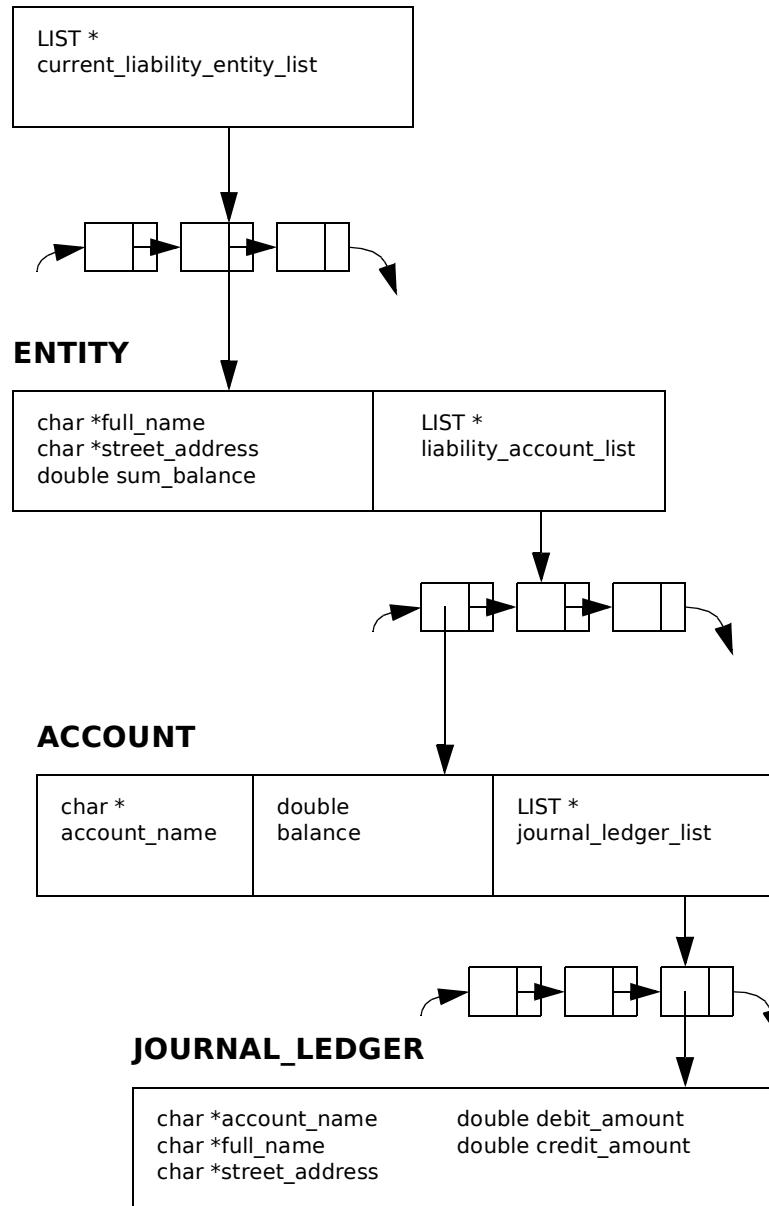

**PAY LIABILITIES\_PROCESS (2)**

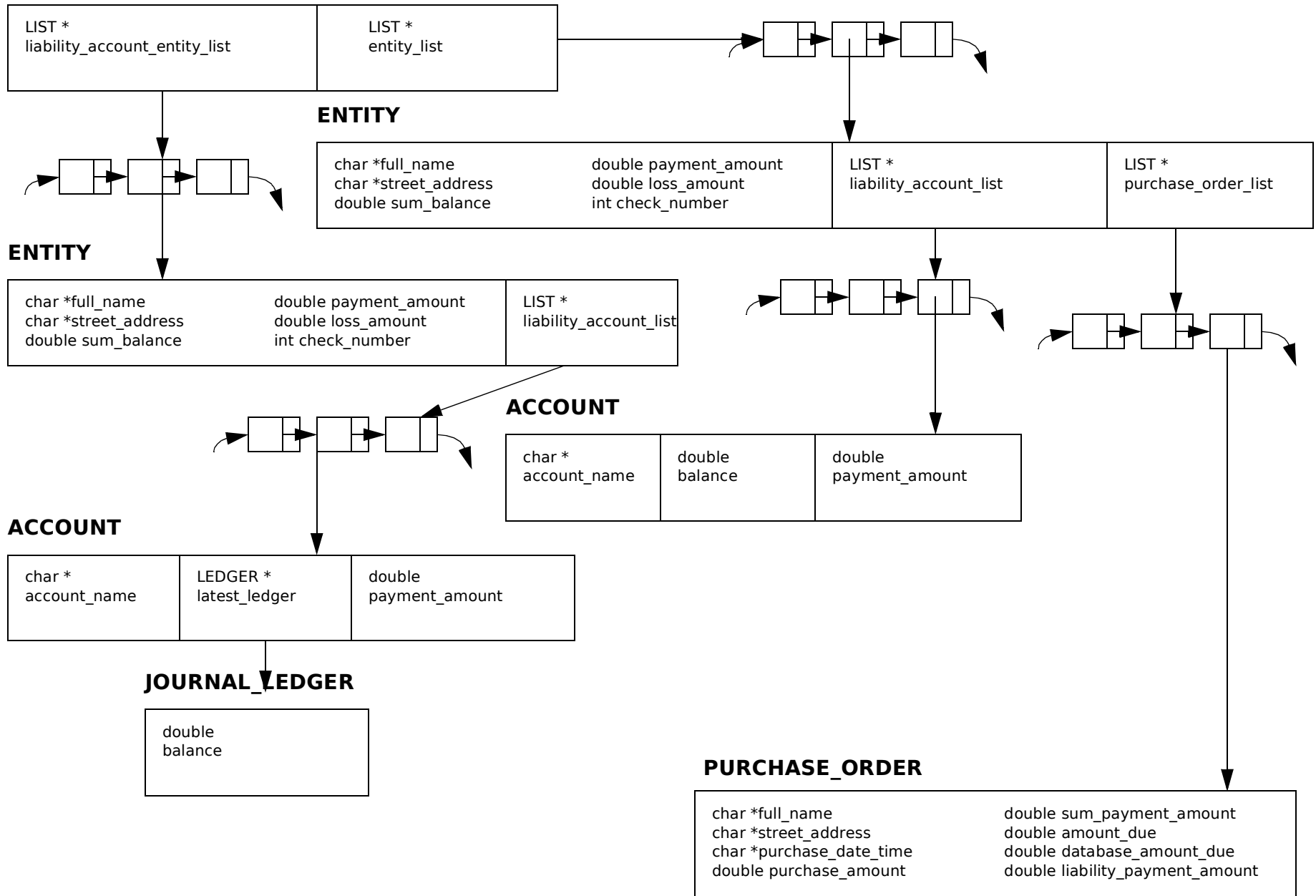



## PAY\_LIABILITIES\_OUTPUT

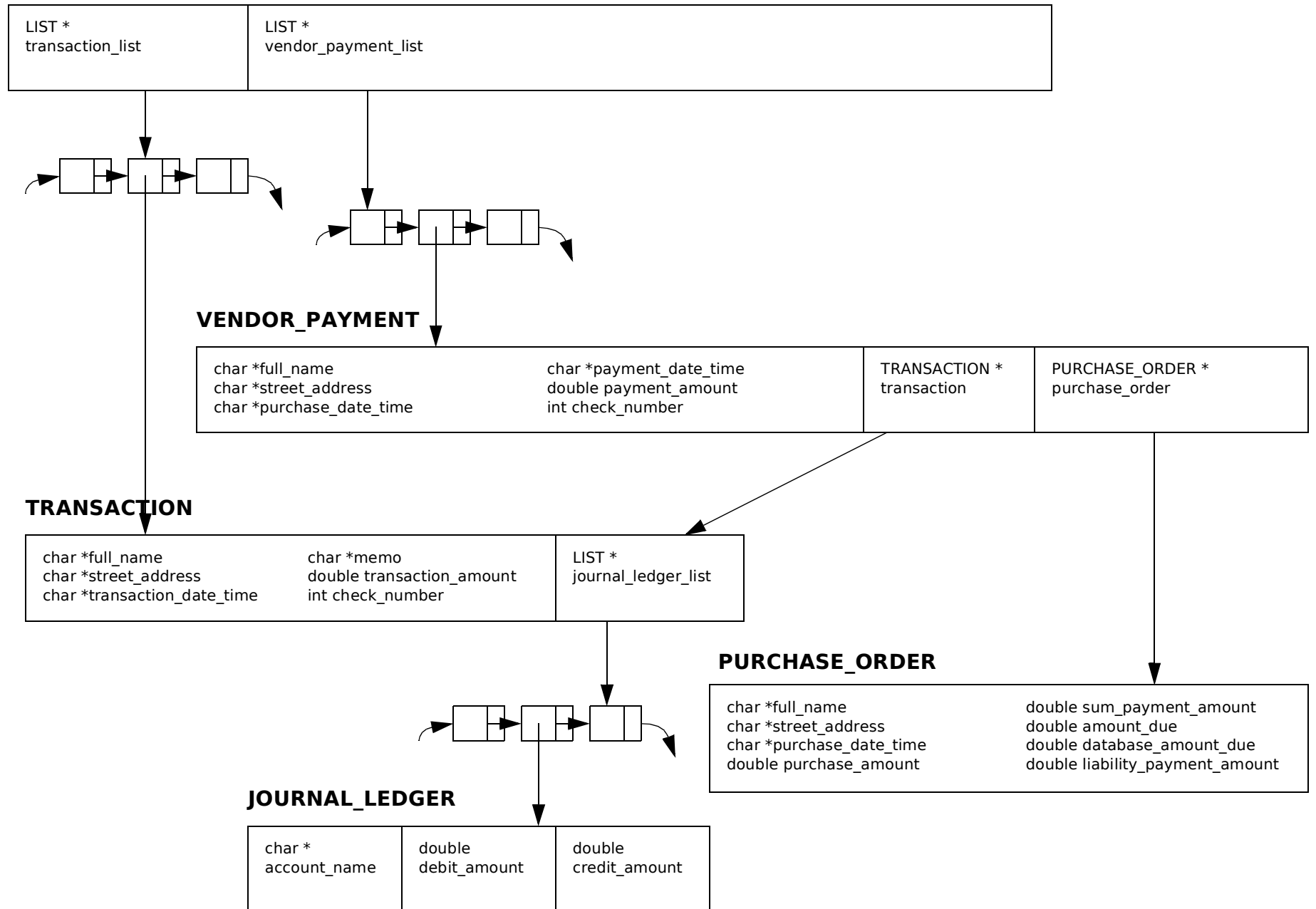

## EMPLOYEE

```

char *full_name
char *street_address
double hourly_wage
double period_salary
double commission_sum_extension_percent
double gross_pay_year_to_date
double database_gross_pay_year_to_date
double net_pay_year_to_date
double database_net_pay_year_to_date
char *federal_marital_status
int federal_withholding_allowances
int federal_withholding_additional_period_amount
boolean state_withholding_exempt
    
```

```

char *state_marital_status
int state_withholding_allowances
int state_itemized_deduction_allowances
int retirement_contribution_plan_employee_period_amount
int retirement_contribution_plan_employer_period_amount
int health_insurance_employee_period_amount
int health_insurance_employer_period_amount
double union_dues_period_amount
char *terminated_date
    
```

LIST \*  
employee\_work\_day\_list

LIST \*  
employee\_work\_period\_list

LIST \*  
customer\_sale\_list

## CUSTOMER\_SALE

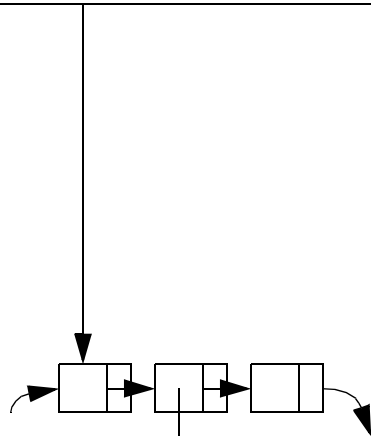

## EMPLOYEE WORK DAY

```

char *begin_work_date_time
char *end_work_date_time
double employee_work_hours
double database_employee_work_hours
boolean overtime_work_day
    
```

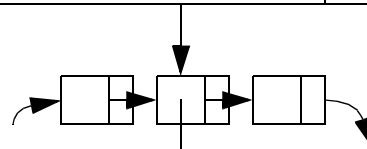

## EMPLOYEE WORK PERIOD

```

char *full_name
char *street_address
int payroll_year
int payroll_period_number
char *begin_work_date
char *end_work_date
double regular_work_hours
double overtime_work_hours
double commission_sum_extension
double gross_pay
double net_pay
double payroll_tax_amount
double federal_tax_withholding_amount
double state_tax_withholding_amount
double social_security_employee_tax_amount
double social_security_employer_tax_amount
double medicare_employee_tax_amount
double medicare_employer_tax_amount
int
retirement_contribution_plan_employee_amount
int retirement_contribution_plan_employer_amount
int health_insurance_employee_amount
int health_insurance_employer_amount
double federal_unemployment_tax_amount
double state_unemployment_tax_amount
int union_dues_amount
char *transaction_date_time
    
```

TRANSACTION \*  
transaction

## TRANSACTION

**PAYROLL\_POSTING**

```
int payroll_year
int payroll_period_number
char *begin_work_date
char *end_work_date
double regular_work_hours
double overtime_work_hours
double commission_sum_extgension
double gross_pay
double net_pay
double payroll_tax_amount
double federal_tax_withholding_amount
double state_tax_withholding_amount
double social_security_employee_tax_amount
double social_security_employer_tax_amount
double medicare_employee_tax_amount
double medicare_employer_tax_amount
int retirement_contribution_plan_employee_amount
int retirement_contribution_plan_employer_amount
int health_insurance_employee_amount
int health_insurance_employer_amount
double federal_unemployment_tax_amount
double state_unemployment_tax_amount
int union_dues_amount
```

---

```
LIST *
employee_work_period_list
```

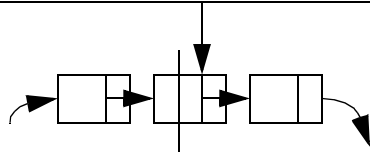

**EMPLOYEE WORK PERIOD**

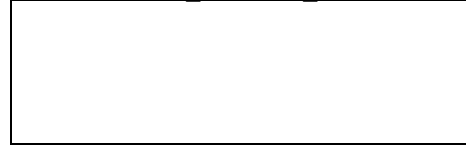

**EMPLOYEE\_TAX\_WITHHOLDING\_TABLE**

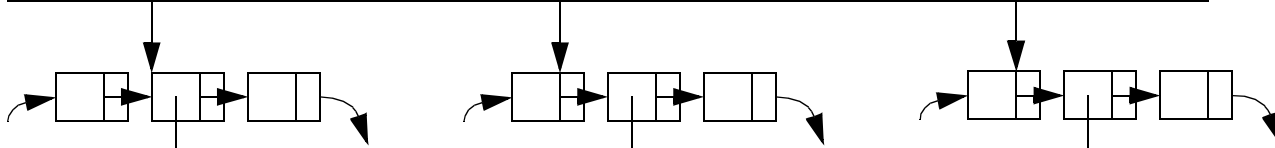
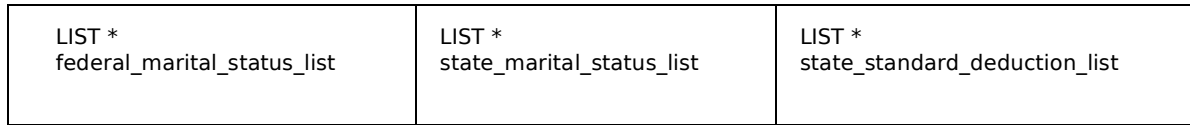

**EMPLOYEE\_MARITAL\_STATUS\_WITHHOLDING**

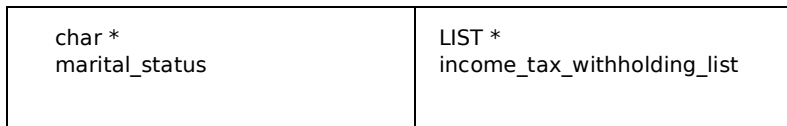

**EMPLOYEE\_STATE\_STANDARD\_DEDUCTION**

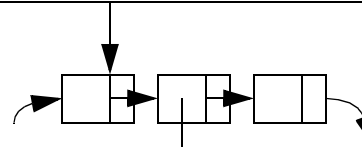
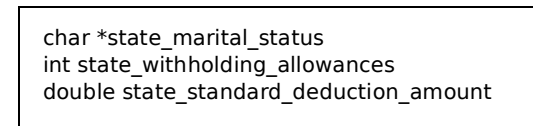

**EMPLOYEE\_INCOME\_TAX\_WITHHOLDING**

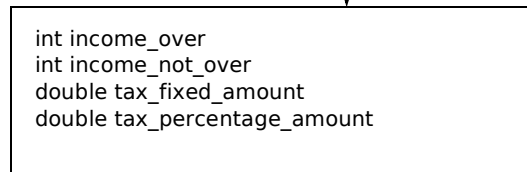

## SUBSIDIARY\_TRANSACTION

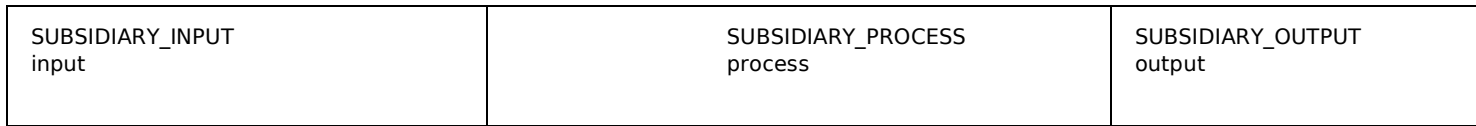

### SUBSIDIARY\_INPUT

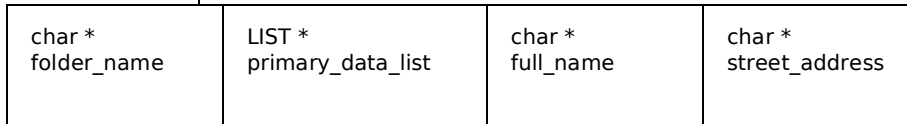

### SUBSIDIARY\_PROCESS

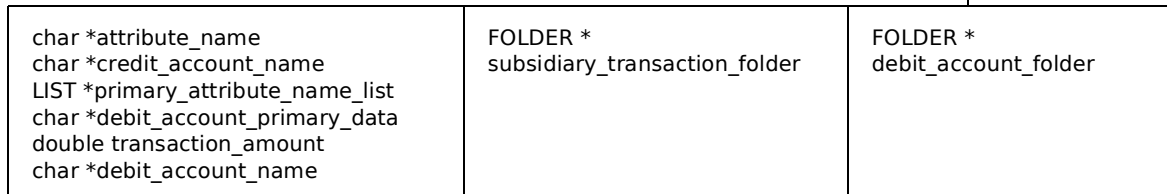

### FOLDER

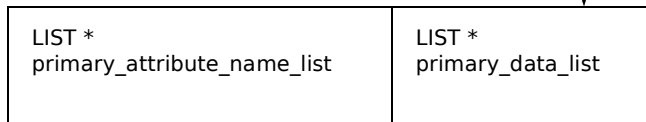

### FOLDER

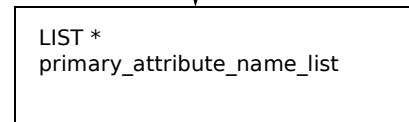

Expect a list of one element. Only single attribute primary key.

### SUBSIDIARY\_OUTPUT

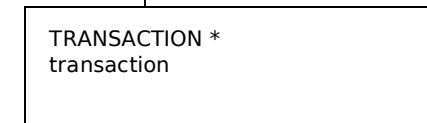

### TRANSACTION

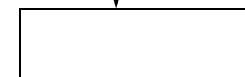

**BANK\_UPLOAD\_STRUCTURE**

BANK_UPLOAD_FILE file	BANK_UPLOAD_TABLE table	LIST * existing_cash_journal_ledger_list	REOCCURRING_STRUCTURE * reoccurring_structure
--------------------------	----------------------------	---	--

int starting\_sequence\_number  
char \* fund\_name  
char \* bank\_upload\_date\_time

**BANK\_UPLOAD\_FILE**



**BANK\_UPLOAD\_TABLE**

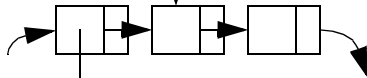

**JOURNAL LEDGER**

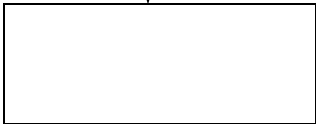

**REOCCURRING\_STRUCTURE**



## BANK\_UPLOAD\_FILE

LIST *	char * input_filename	int	date_piece_offset
bank_upload_file_list	char * file_sha256sum	int	description_piece_offset
	char * minimum_bank_date	int	debit_piece_offset
	int file_row_count	int	credit_piece_offset
	int table_insert_count	int	balance_piece_offset

## BANK\_UPLOAD\_TABLE

LIST *
bank_upload_table_list

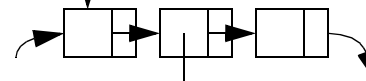
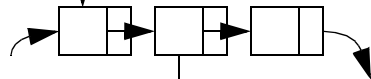

## BANK\_UPLOAD

char *bank_date char *bank_description int sequence_number double bank_amount double bank_running_balance char *fund_name	TRANSACTION * transaction
--	------------------------------

## TRANSACTION

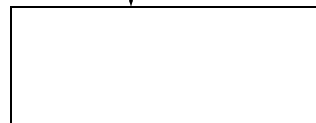

## REOCCURRING\_STRUCTURE

```
LIST *  
reoccurring_transaction_list
```

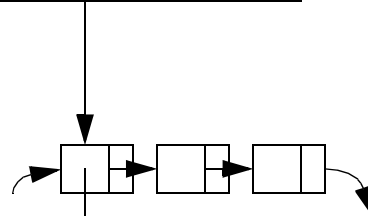

## REOCCURRING\_TRANSACTION

```
char *full_name  
char *street_address  
char *transaction_description  
char *debit_account  
char *credit_account  
double transaction_amount  
char *bank_upload_search_phrase  
double accrued_daily_amount  
double accrued_monthly_amount  
char *rental_property_street_address
```

optional



## TAX

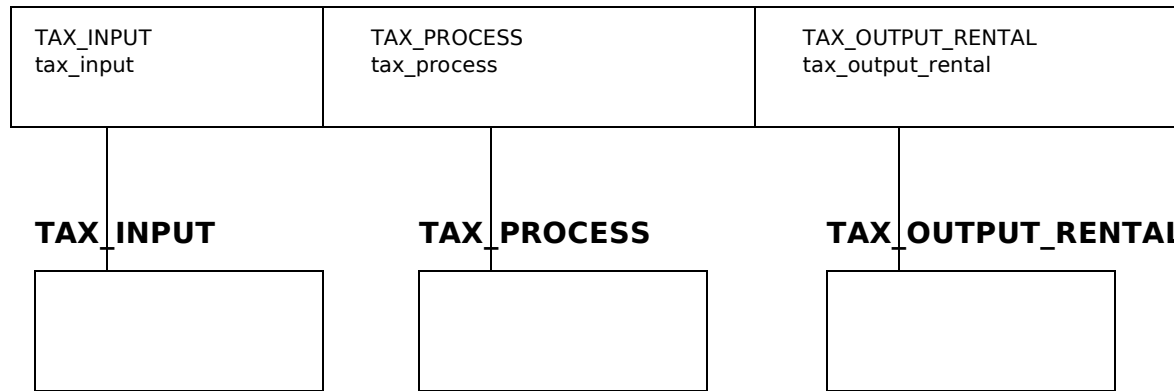

**TAX\_INPUT**

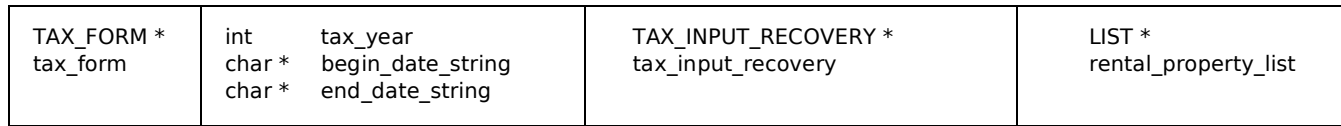

**TAX\_INPUT\_RECOVERY**

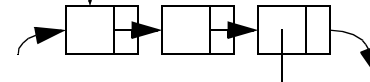
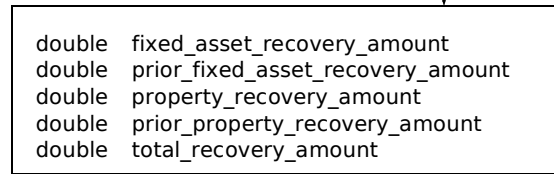

**TAX\_INPUT\_RENTAL\_PROPERTY**

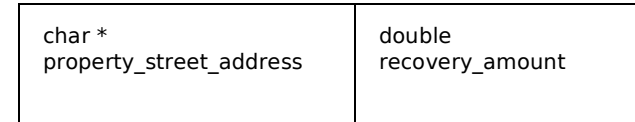

**TAX\_FORM**

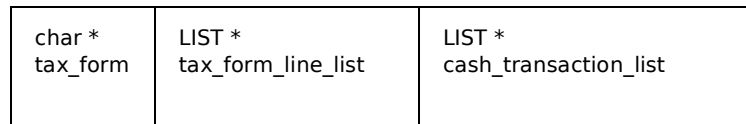

**TRANSACTION**

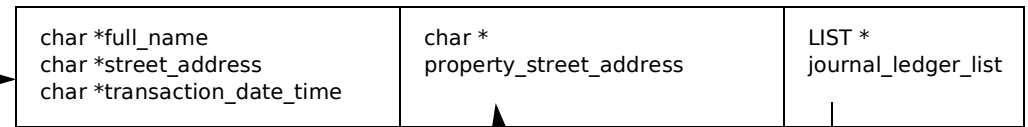

optional, used for Schedule E

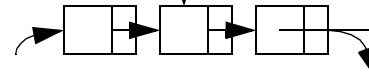
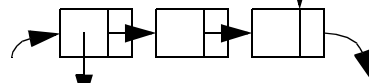

**TAX\_FORM\_LINE**

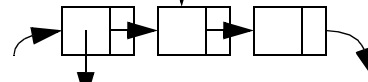
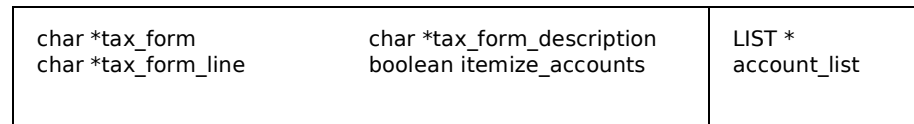

**TAX\_FORM\_LINE\_ACCOUNT**

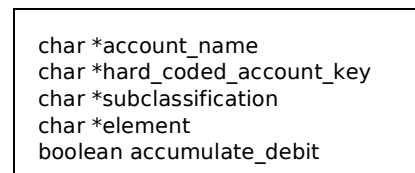

**JOURNAL\_LEDGER**

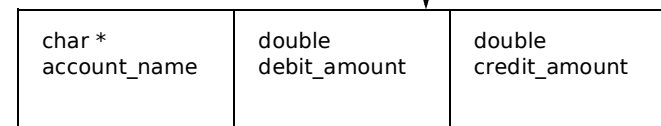

## TAX\_PROCESS

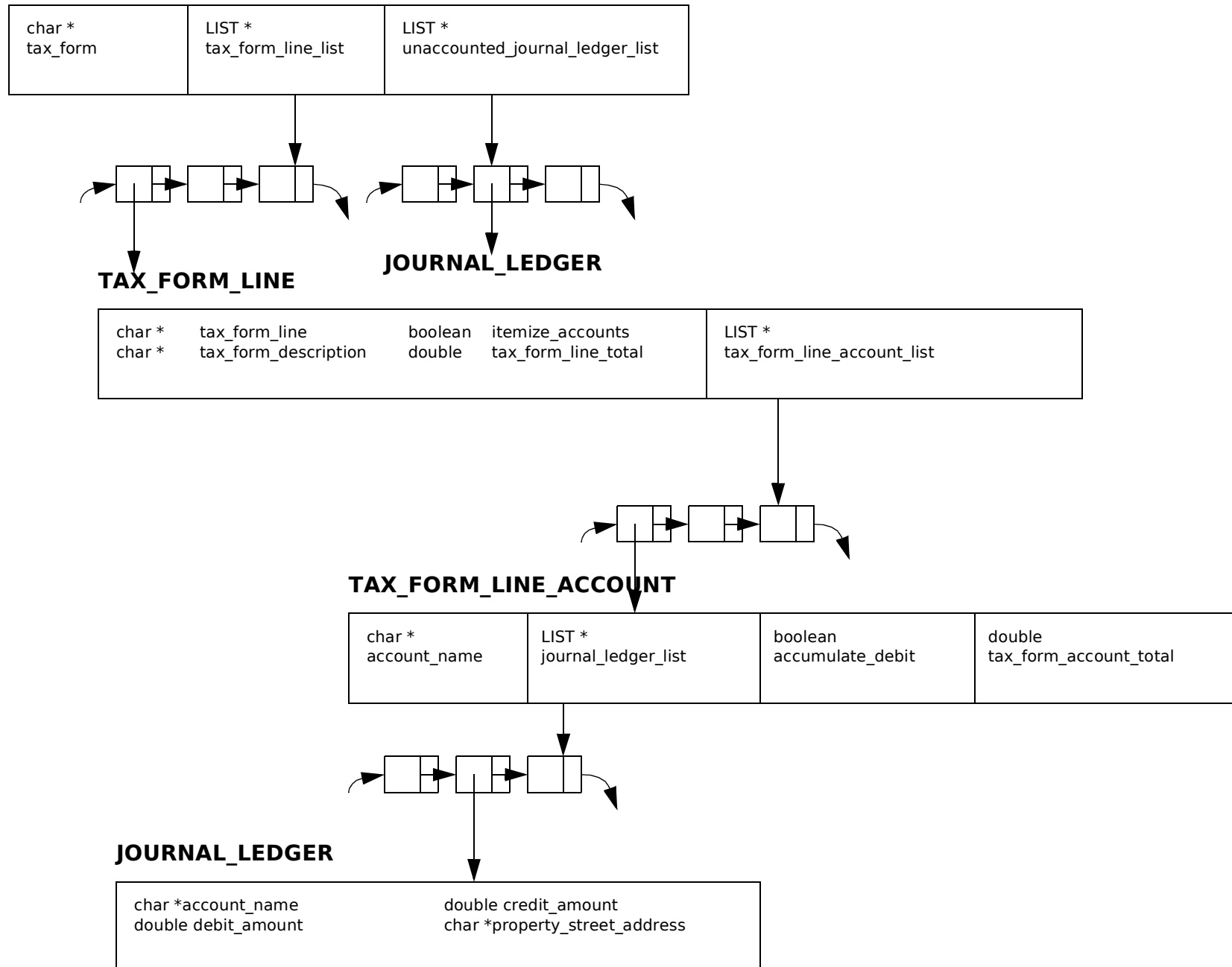

## TAX\_OUTPUT\_RENTAL

LIST * tax_form_line_rental_list	double revenue_total [23a] double mortgage_interest_total [23c] double depreciation_total [23d]	double expense_total [23e] double positive_net_income [24] double loss_total [25]
-------------------------------------	---	---

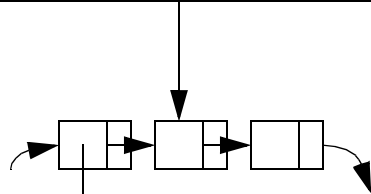

## TAX\_FORM\_LINE\_RENTAL

char *tax_form_line char *tax_form_description	enum tax_form_line_category tax_form_line_category	LIST * tax_form_line_account_list	LIST * rental_property_list
---	---	--------------------------------------	--------------------------------

revenue  
mortgage\_interest\_paid  
depreciation\_expense  
operating\_expense  
loss

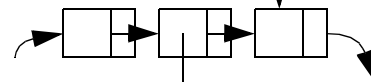

## TAX\_FORM\_LINE\_ACCOUNT

char * account_name	LIST * journal_ledger_list	boolean accumulate_debit
------------------------	-------------------------------	-----------------------------

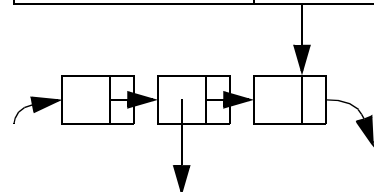

## JOURNAL\_LEDGER

char *account_name double debit_amount	double credit_amount char *property_street_address
---	---

## TAX\_OUTPUT\_RENTAL\_PROPERTY

char * property_street_address	double tax_form_line_total
-----------------------------------	-------------------------------

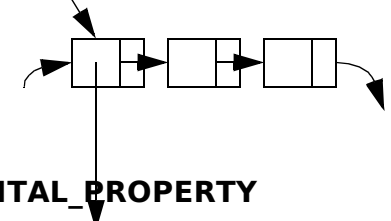

**INVESTMENT\_EQUITY**

INVESTMENT_INPUT investment_input	INVESTMENT_PROCESS * investment_process	INVESTMENT_ACCOUNT investment_account	LIST * input_account_balance_list	LIST * output_account_balance_list
--------------------------------------	--	--	--------------------------------------	---------------------------------------

**INVESTMENT\_PROCESS**

```
enum preupdate_change_state
full_name_change_state
street_address_change_state
account_number_change_state
date_time_change_state
char *earlier_date_time
char *begin_date_time
```

**INVESTMENT\_ACCOUNT**

```
char *full_name
char *street_adress
char *account_number
char *investment_account
char *fair_value_adjustment_account
char *classification
```

**INVESTMENT\_INPUT**

```
char *date_time
char *fund_name
char *state
char *preupdate_full_name
char *preupdate_street_address
char *preupdate_account_number
char *preupdate_date_time
```

**ACCOUNT\_BALANCE**

```
char *date_time
char *investment_operation
double share_price
double share_quantity_change
double share_quantity_balance
double cash_in
double market_value
double book_value_change
double book_value_balance
double moving_share_price
double unrealized_gain_balance
double unrealized_gain_change
double reaqlized_gain
boolean table_first_row
char *transaction_date_time
TRANSACTION *
transaction
```

**TRANSACTION**

```
TRANSACTION *
transaction
```

